

	Kg.
	cm.



PC & Macbook
<https://get.adobe.com/uk/reader/>

Tablet & iPad
<https://www.adobe.com/acrobat/mobile.html>

ENG 

DE 

FR 

DK 

FAUTEUIL ROULANT SUR MESURE



21000000100?		
4.900 €		

Fill in and send to Wolturnus - Udfyld og send til Wolturnus

Subject to Technical Modifications and Printing Errors / Technische Änderungen und Druckfehler vorbehalten
Forbehold for tekniske ændringer og trykfejl

619000001009		
619000001109		
619000001209		
619000001309		
619000001409		
619000001509		
619000003709		
619000003809		
619000003909		
619000003209		
619000002009		
619000002109		
619000002509		
619000002609		
619000002809		
619000003309		
619000003409		
619000003509		
619000003609		
619000003009 765 €		
000000001102 0 €		

© Wolturnus A/S W5jr, Winter 2024, v4.0

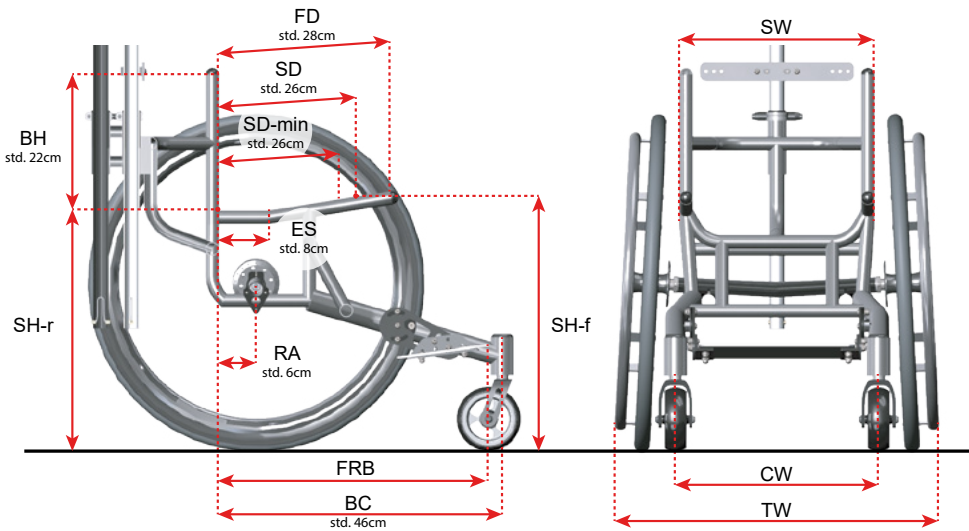

	!		SW: _____ cm
	!		FD: _____ cm
			SD: _____ cm
			SD-min: _____ cm
	!		SH-r _____ cm
	!		SH-f: _____ cm
	!		C: _____ °
812199000010 58 € 812199000011 58 €			BH: _____ cm
	!		BH-d: _____ cm
			BH-max: _____ cm
			BH-min: _____ cm
	!		RA: _____ cm
610000001009 610000??0001 260 €			ES: _____ cm
			BC: _____ cm
			CW: _____ cm
			TW: _____ cm

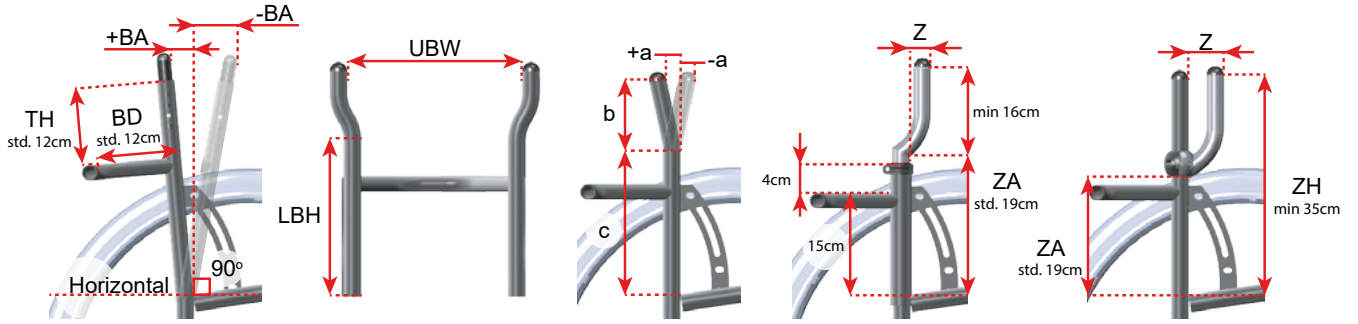

813100050???			
0 €			
813100051???			BA: _____ ±cm
374 €			
813100051???			
374 €			
		!	BD: _____ cm
			TH: _____ cm

8122002001??			
574 €			
8122002001??			_____ cm
739 €		!	
82501000????			
572 €			ZA: _____ cm
8122002001??			Z: _____ cm
950 €			ZH: _____ cm
8122002001??			
950 €			

8861101013??			
332 €			
8861101013??			
332 €			
886110102001			AF: _____ cm
332 €			AW: _____ cm



--	--

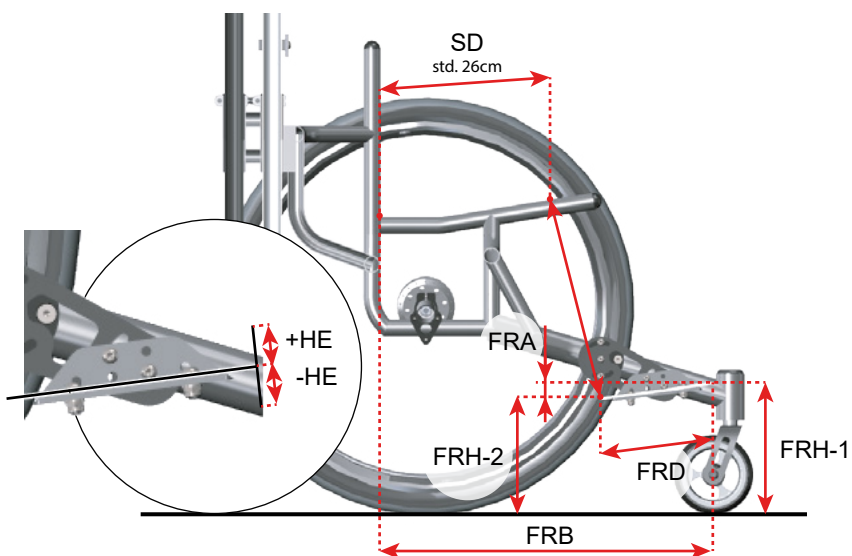

			VSL/USL: _____ cm
			FRH-1: _____ cm
			FRH-2: _____ cm
			-1,5 -3 +1,5 +3
823028991500 0 €			FRB: _____ cm
821920869000 536 €			FRD: _____ cm
			FRA: _____ cm
835099210001 69 €	!		
829999012001 38 €			HE: _____ ±cm



--	--

Fill in and send to Wolturnus - Ausfüllen und an Wolturnus senden - Udfyld og send til Wolturnus

Subject to Technical Modifications and Printing Errors / Technische Änderungen und Druckfehler vorbehalten
Forbehold for tekniske ændringer og trykfejl

			1+	2+	3+	4+	5+
761000000010 250 €							



710000000001 0 €						
710099990010 450 €						
710099990012 480 €						
710099990013 480 €						
710099990011 480 €						

710099990000 0 €						
710099990003 189 €						
710099990004 189 €						
710099990002 189 €						
710099990001 0 €						

750000009000 270 €			!			
- 0 €			_____ cm / _____ cm			
750000000005 70 €	!		5cm Std.		7cm	
			Medium Std.		Hard	

<p>885110101001 0 €</p>			
<p>885110101003 0 €</p>			
<p>885110111001 203 €</p>			
<p>885110122002 60 € 88511012200? 120 €</p>			
<p>885110301009 702 € 885110301009 702 €</p>			
<p>885110101101 203 €</p>			
<p>885110111101 203 €</p>			
<p>951519204000 92 € 184 €</p>			
<p>885110201209 230 €</p>			
<p>885110301015 867 €</p>			

--	--

				
881000100003 0 €				
881000600003 0 €				
881000?0000 347 €				
88100010000? 0 €				
88100020000? 741 €				
88100030000? 818 €				



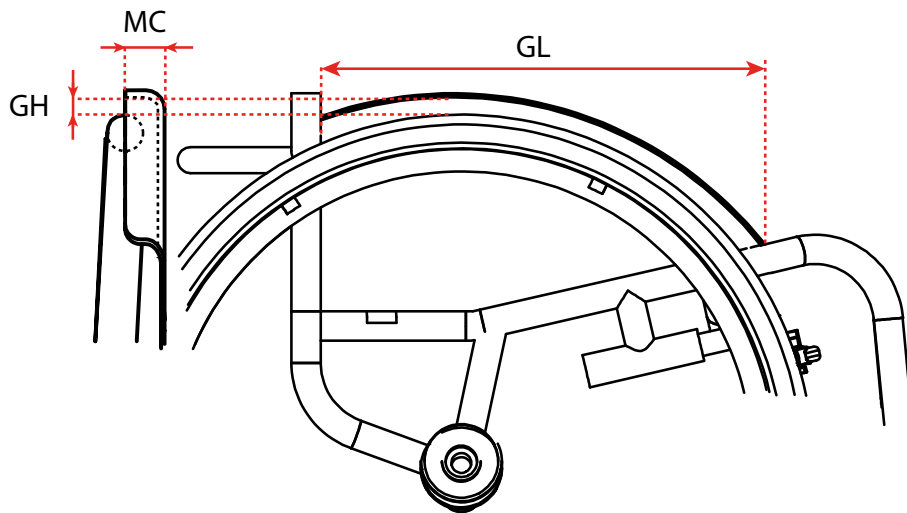

681000010002 75 €			
7670000000?? 174 €			

	GH:	_____ cm
	GL:	_____ cm
	MC:	_____ cm

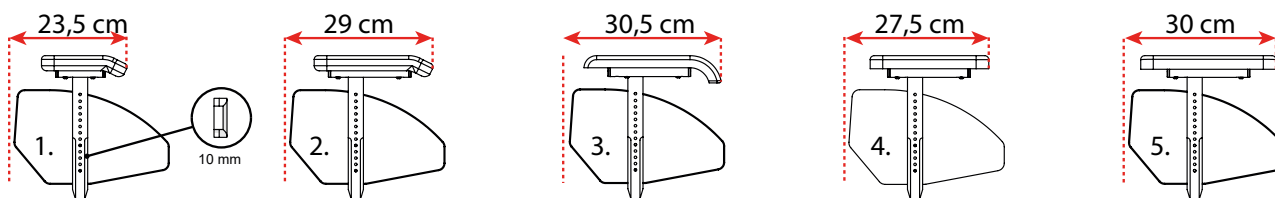

--	--



951000080119 562 €			AB = 23,5 cm AL = 16 cm	
881001000003 562 €			AB = 29 cm AL = 23,5 cm	
881001100003 562 €			AB = 30,5 cm AL = 27,5 cm	
881001200003 562 €			AB = 27,5 cm AL = 23,5 cm	
881001300003 562 €			AB = 30 cm AL = 27 cm	
681000010007 97 €				

!	AS: _____ cm
---	--------------

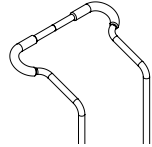
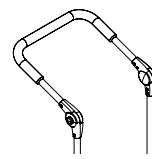
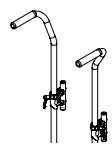

885200031005 390 €				
88520003100? 664 €				
88520003100? 664 €				
88520003100? 664 €				
88520003100? 664 €				
885200011501 536 €			5 cm 10 cm 15 cm	
	!			_____ cm

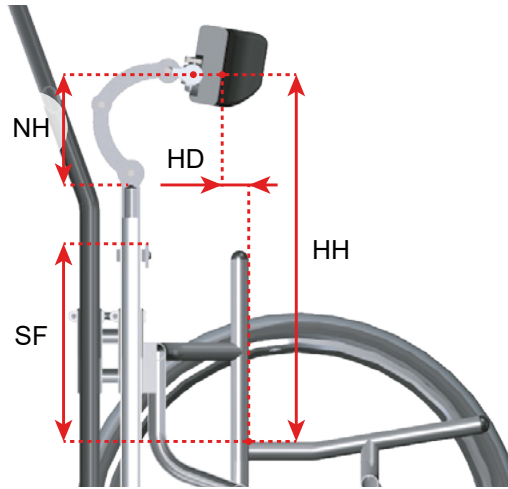
--	--



Fill in and send to Wolturnus - Ausfüllen und an Wolturnus senden - Udfyld og send til Wolturnus

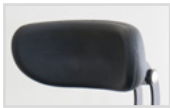







Subject to Technical Modifications and Printing Errors / Technische Änderungen und Druckfehler vorbehalten
Forbehold for tekniske ændringer og trykfejl

884100013001 245 €								
884100014001 353 €								
951000080130 92 €				NH: _____ cm				
951000080131 112 €								
951000080141 112 €						HH: _____ cm		
951000080142 112 €								
840000100831 184 €								
840000100832 215 €								HD: _____ cm
884100250100 194 €				SF: _____ cm				

887000200001 509 €				
------------------------------	--	--	--	--



7600000100?? 70 € 64 €					
--	--	--	--	--	---



--	--

860010201251	0 €	Std.	LED
860010201000	0 €	 	
860010201001	0 €		
860010200801	0 €		
860010101401	0 €	40mm	
860010101253	0 €		
860010101002	0 €		
860010200910	182 €		
860010200900	182 €		
8600101015??	481 €		
8600101015??	481 €		
86001010201?	0 €		
	0 €		
	0 €		
8600101020??	0 €		
	0 €		
860020000000	+53 €		
86001020150?	332 €		
	332 €		
860010201???	332 €		
	332 €		
	332 €		
860010201???	332 €		
	332 €		
	332 €		
	332 €		
860010201???	385 €		
	385 €		
	385 €		
	385 €		
860010201???	385 €		
	385 €		
	385 €		
	385 €		
	0 €		
	164 €		
	164 €		
	164 €		
885201001001	613 €		
862400001009	321 €		

--	--	--	--	--	--

	20"	22"	24"			
85102??01009				0 €		
85102?10100?	-	-		0 €		
8510??101002	-			263 €		
851124201009	-	-		481 €		
853728111019 853728111020	-			835 €		!
8537281110??	-			1.338 €		!

	20"	22"	24"			
85352?101008				915 €		
85352?101208				915 €		
85352?101508	-			915 €		
85352?101308				915 €		
85352?102108				915 €		
85352?101009				710 €		
85352?101209				710 €		
85352?101509				710 €		
85352?101309				710 €		
85352?101?09				710 €		

85352?101608				971 €		
85352?101408				971 €		
85352?101808	-	-		971 €		
85352?101708				971 €		
85362?241008				971 €		
85362?241208				971 €		
85362?241508	-	-		971 €		
85362?241308				971 €		
85362?181008				971 €		
85362?181208				971 €		
85362?181508	-	-		971 €		
85362?181308				971 €		

--	--

Fill in and send to Wolturnus - Ausfüllen und an Wolturnus senden - Udfyld og send til Wolturnus

Subject to Technical Modifications and Printing Errors / Technische Änderungen und Druckfehler vorbehalten
Forbehold for tekniske ændringer og trykfejl

© Wolturnus A/S W5jr. Winter 2024, v4.0

	20"	22"	24"		
96622?010001				0 €	
96622?01000?	-			70 €	
96622?010009				150 €	
96622?010021	-	-		150 €	
966224010013	-	-		70 €	
96622?011008	-	-		70 €	
966224010007	-	-		70 €	

85512?10200?				0 €	
85512?102008				198 €	
85502?103009	-	-		182 €	
85552?000009				514 €	
8554202?0601				322 €	

85712?102009				182 €	
--------------	--	--	--	--------------	--

85712?102117 332 €					
85712?102109 332 €					
85712?102115 332 €					
85712?102116 332 €					
85712?102111 332 €					
85712?102114 332 €					
85712?102110 332 €					
85712?102112 332 €					
85712?102113 332 €					
85712?102118 332 €					

--	--	--	--	--	--

--	--	--	--	--	--

000000001104 110 €		EN ISO 14971
P.4		
P.5		
P.6		
P.7		
P.8		
P.9		
P.10		
P.11		
P.12		
P.13		
P.14		

