



**Tailor-made Wheelchair**



171000005000		
<b>5800 €</b>		
17100000500?		
<b>5900 €</b>		

619000001009			
619000001109			
619000001209			
619000001309			
619000001409			
619000001509			
619000002009			
619000002109			
619000002509			
619000002809			
619000003209			
619000003309			
619000003409			
619000003509			
619000003709			
619000003809			
619000003909			
619000003009			
<b>765 €</b>			
000000001102			
<b>0 €</b>			

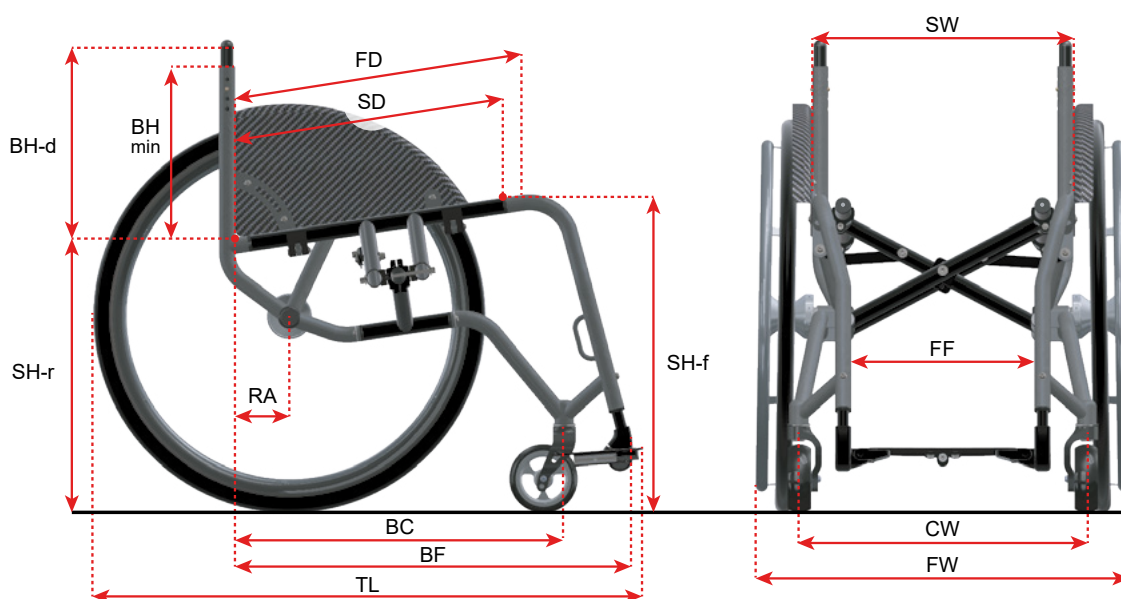

171000010??	!			<b>SW:</b> _____ cm
				<b>FD:</b> _____ cm
				<b>SD:</b> _____ cm
				<b>SH-r</b> _____ cm
				<b>SH-f:</b> _____ cm
				<b>C:</b> _____ °
				<b>BH:</b> _____ cm
				<b>BH-d:</b> _____ cm
				<b>BH-max:</b> _____ cm
				<b>BH-min:</b> _____ cm
				<b>RA:</b> _____ cm
				<b>BF:</b> _____ cm
				<b>BC:</b> _____ cm
				<b>CW:</b> _____ cm
				<b>TW:</b> _____ cm

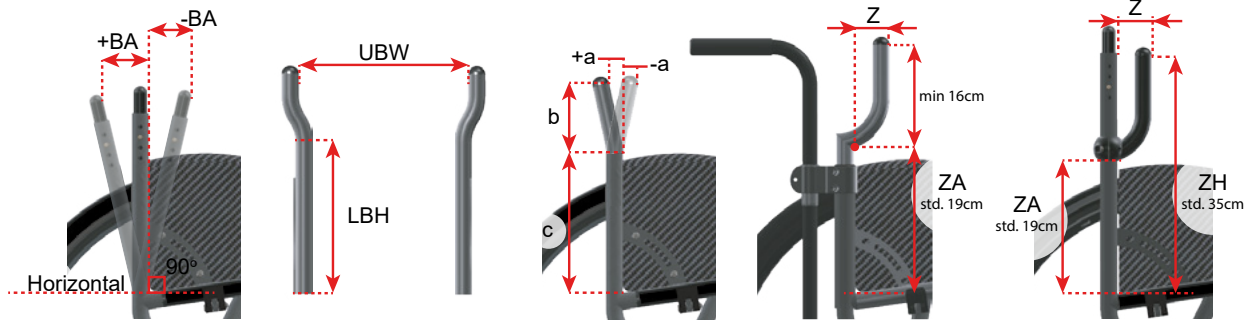

			<b>BA:</b> _____ ±cm
812200200002 <b>251 €</b>			<b>UBW:</b> _____ cm
812200200001 <b>251 €</b>			<b>LBH:</b> _____ cm
812200200020 <b>150 €</b>			<b>a:</b> _____ cm
			<b>b:</b> _____ cm
			<b>c:</b> _____ cm
8122002001?? <b>572 €</b> 8122002001?? <b>739 €</b> 82501000???? <b>572 €</b>	<b>!</b>		_____ cm
			<b>ZA:</b> _____ cm
			<b>Z:</b> _____ cm
			<b>ZH:</b> _____ cm
8861101013?? <b>332 €</b> 8861101013?? <b>332 €</b>			
			<b>AF:</b> _____ cm
			<b>AW:</b> _____ cm



--	--

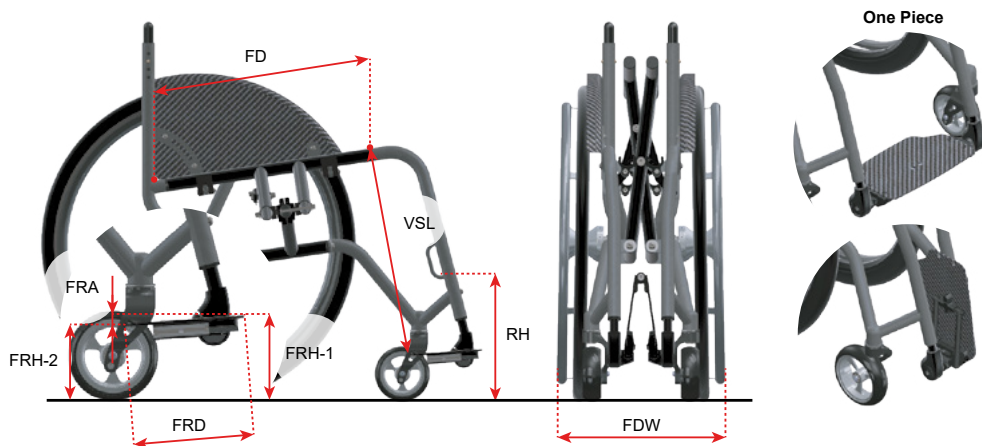



			VSL/USL: _____ cm
			FRH-1: _____ cm
			FRH-2: _____ cm
			-1,5   -3 +1,5   +3
			FRA: _____ cm
8350??010001 <b>0 €</b>			
8350??020001 <b>0 €</b>			
8350??030001 <b>0 €</b>			
8350??030001 <b>0 €</b>			
8350??050001 <b>471 €</b>		FF 22cm FF 24cm FF 26cm FF 28cm FF 30cm FF 32cm FF 34cm	
8350??060001 <b>711 €</b>		FF 22cm FF 24cm FF 26cm FF 28cm FF 30cm FF 32cm FF 34cm FF 36cm FF 38cm FF 40cm	
835099210001 <b>69 €</b>			
691000010001 <b>70 €</b>			RH: _____ cm

Fill in and send to Wolturnus - Ausfüllen und an Wolturnus senden - Udfyld og send til Wolturnus

Subject to Technical Modifications and Printing Errors / Technische Änderungen und Druckfehler vorbehalten  
Forbehold for tekniske ændringer og trykfejl

© Wolturnus A/S Merlin Winter 2024 V4.0

				1+	2+	3+	4+	5+
761000000010 <b>250 €</b>								
710000000001 <b>0 €</b>								
710099990010 <b>450 €</b>								
710099990012 <b>480 €</b>								
710099990013 <b>480 €</b>								
710099990011 <b>480 €</b>								
710099990001 <b>0 €</b>								
710099990003 <b>189 €</b>								
710099990004 <b>189 €</b>								
710099990002 <b>189 €</b>								
710099990000 <b>0 €</b>								
750000009000 <b>270 €</b>				!				
- <b>0 €</b>						_____ cm / _____ cm		
750000000005 <b>70 €</b>		!				5cm Std.	7cm	
						Medium Std.	Hard	

				
881000100003 <b>0 €</b>				
881000600003 <b>0 €</b>				
881000?0000 <b>347 €</b>				
88100010000? <b>0 €</b>				
88100040000? <b>307 €</b>				
8810005000?? <b>760 €</b>				
88100020000? <b>741 €</b>				
8810003000?? <b>818 €</b>				

883124101014 <b>245 €</b>			
681000010002 <b>75 €</b>			
681000010052 <b>75 €</b>			
7670000000?? <b>174 €</b>			

	<b>GH:</b>	_____ cm
	<b>GL:</b>	_____ cm
	<b>MC:</b>	_____ cm

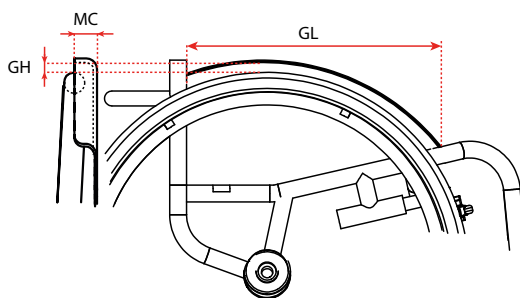



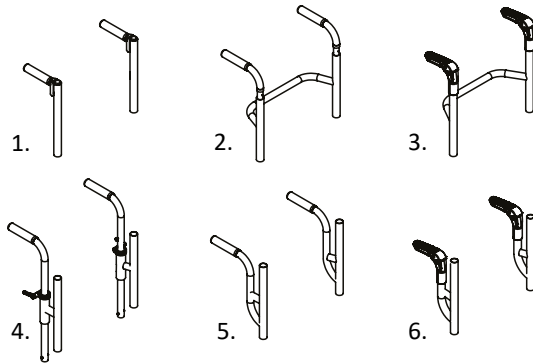

--	--









81310005?106 <b>321 €</b>		1.		
81310005?206 <b>375 €</b>				
81310005?108 <b>321 €</b>		2.		
81310005?208 <b>375 €</b>				
81310005?107 <b>187 €</b>	3.			
81310005?207 <b>235 €</b>				
81310005??02 <b>536 €</b>		4.		
81310005??04 <b>375 €</b>		5.		
81310005??05 <b>589 €</b>		6.		
				PH: _____ cm

69100002002? <b>280 €</b>			
886210101001 <b>347 €</b>			
7600000100?? <b>70 €</b>			
76100000000? <b>166 €</b> <b>230 €</b>			
7711000007?? <b>112 €</b> <b>112 €</b> <b>112 €</b>			 
771100000747 <b>112 €</b>			
953001040120 <b>112 €</b>			

--	--

885110101101 <b>203 €</b>			
885110111101 <b>203 €</b>			
885110201209 <b>230 €</b>			
885110201300 <b>256 €</b>			

951500020019 <b>72 €</b>			
-----------------------------	--	--	--

966401253410 966401003410	<b>182 €</b> <b>182 €</b>		
------------------------------	------------------------------	--	---



966401253400 966401003400 966401003403 966401003402 966401003401 966401003404	<b>0 €</b> <b>0 €</b> <b>0 €</b> <b>0 €</b> <b>0 €</b> <b>0 €</b>		
--	--	--	--



966401250120 966401250220 966401250320 966401250020	<b>332 €</b> <b>332 €</b> <b>332 €</b> <b>332 €</b>		
966401000120 966401000220 966401000320 966401000020	<b>332 €</b> <b>332 €</b> <b>332 €</b> <b>332 €</b>		
966401250?20 966401250620 966401250520 966401250420	<b>385 €</b> <b>385 €</b> <b>385 €</b> <b>385 €</b>		
966401000?20 966401000620 966401000520 966401000420	<b>385 €</b> <b>385 €</b> <b>385 €</b> <b>385 €</b>		

9521000000?	<b>0 €</b>		
	<b>0 €</b>		

--	--	--	--

	22"	24"	25"	26"	
85102??01009					0 €
85102?10100?	-			-	0 €
8510??101002				-	263 €
851124201009	-		-	-	481 €

	22"	24"	25"	26"		
85352?101008					915 €	
85352?101208					915 €	
85352?101508	-				915 €	
85352?101308					915 €	
85352?102108					915 €	
85352?101009					710 €	
85352?101209					710 €	
85352?101509	-				710 €	
85352?101309					710 €	
85352?101?09					710 €	

85352?101608					971 €	
85352?101408	-			-	971 €	
85352?101808					971 €	
85352?101708					971 €	
85362?241008					971 €	
85362?241208	-				971 €	
85362?241508					971 €	
85362?241308					971 €	
85362?181008					971 €	
85362?181208	-				971 €	
85362?181508					971 €	
85362?181308					971 €	

--	--

	22"	24"	25"	26"	
96622?010001				-	0 €
96622?01000?					70 €
96622?010009					150 €
96622?010021	-				150 €
966224010013	-		-	-	70 €
96622?011008	-		-	-	70 €
966224010007	-				70 €

85512?10200?					0 €
85512?102008	-			-	198 €
85502?103009	-				182 €
85552?000009					514 € 643 €
8554202?0601					332 €
8554262?0601	-				588 €
8554272?0601	-				588 €
8554282?0601					715 €
9669282?0602					715 €
8554302?0601					715 €
8554502?060?	-			-	715 €
8554502?060?	-			-	715 €

			!		
--	--	--	---	--	--

85712?102009					182 €
--------------	--	--	--	--	-------

--	--	--	--	--	--

000000001104 110 €					
-----------------------	--	--	--	--	--

EN ISO 14971

--	--	--	--	--	--

P.4	
P.5	
P.6	
P.8	
P.9	
P.10	
P.11	
P.12	





