

Fill in and send to Wolturnus - Ausfüllen und an Wolturnus senden - Udfyld og send til Wolturnus

Subject to Technical Modifications and Printing Errors / Technische Änderungen und Druckfehler vorbehalten  
Forbehold for tekniske ændringer og trykfejl

© Wolturnus A/S A-Run Winter 2024 v4.0

<b>Kg.</b>	
<b>cm.</b>	







PC & Macbook  
<https://get.adobe.com/uk/reader/>

Tablet & iPad  
<https://www.adobe.com/acrobat/mobile.html>

ENG 

DE 

FR 

DK 

## Tailor-made Wheelchair



231000001000 <b>6.400 €</b>		
231000001010 <b>6.400 €</b>		
231000001020 <b>6.400 €</b>		
231000001030 <b>6.400 €</b>		
231000001040 <b>6.400 €</b>		
231000001050 <b>6.400 €</b>		
231000001060 <b>6.600 €</b>		
231000001070 <b>5.600 €</b>		
500000000006		
500000000006		

619000001609			
619000001709			
619000001809			
619000001909			
619000002009			
619000002109			
619000002509			
619000002609			
619000002809			
619000003309			
619000003409			
619000003509			
619000003609			
619000003009			
<b>765 €</b>			
000000001102			
<b>500 €</b>			

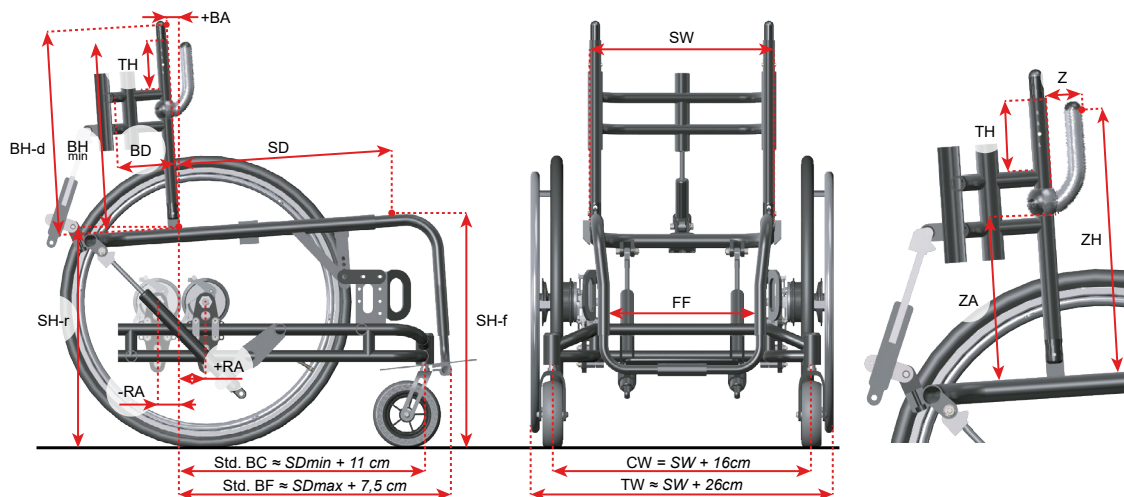

	!		SW: _____ cm
	!		SD: _____ cm
	!		SH-r _____ cm
	!		SH-f: _____ cm
	!		C: _____ °
	!		BH-d: _____ cm
	!		BH-max: _____ cm
	!		BH-min: _____ cm
887000100010 0 €	!		BA: _____ cm
811100000000 577 €			
811100002005 256 €			
611000??0009 0 €	!		RA: _____ cm
691100000090 567 €			
61000001009 0 €	!		ES: _____ cm
610000??0001 260 €			
			TW: _____ cm
			FF: _____ cm

Fill in and send to Wolturnus - Ausfüllen und an Wolturnus senden - Udfyld og send til Wolturnus

980001500150 <b>0 €</b>		
88700014000? <b>3066 €</b> <b>4088 €</b>		

8122002001?? <b>739 €</b>				
8122002001?? <b>739 €</b>				
	!			ZH: _____ cm
	!			ZA: _____ cm
8122002001?? <b>950 €</b>				Z: _____ cm ZH: _____ cm

				VSL/USL: _____ cm
	!	SW 26 cm = VSL 28 cm +/- 3 cm	SW 30 cm = VSL 32 cm +/- 3 cm	SW 34 cm = VSL 36 cm +/- 3 cm
		SW 38 cm = VSL 38 cm +/- 3 cm	SW 42 cm = VSL 40 cm +/- 3 cm	SW 45 cm = VSL 40 cm +/- 3 cm
				-1,5   -3 +1,5   +3



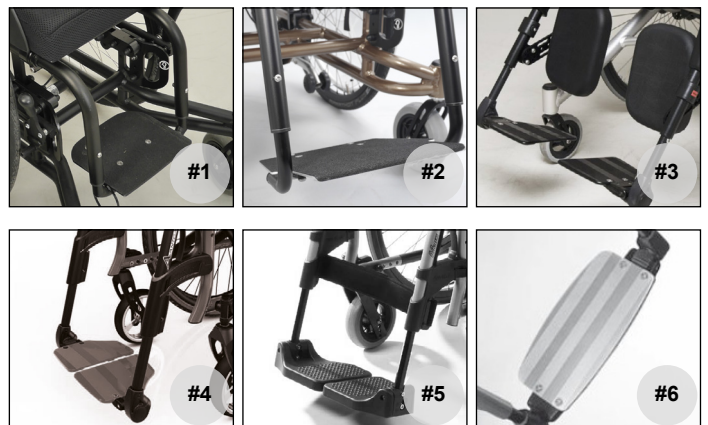
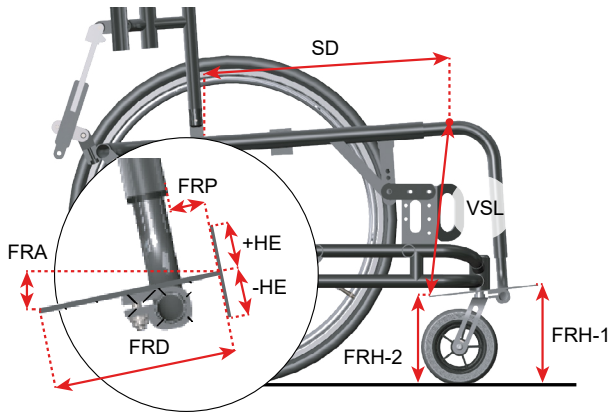



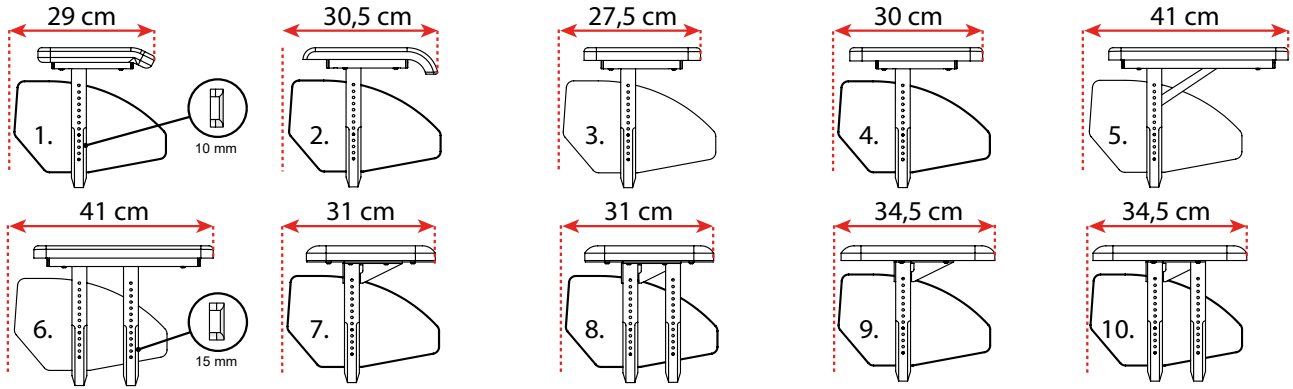

950599992?50 <b>0 €</b>				FRP: _____ cm
8299990?000? <b>321 €</b> <b>390 €</b> <b>536 €</b>				FRD: _____ cm FRP: _____ cm +/- HE: _____ cm
8???999?1?00? <b>69 €</b> <b>294 €</b>				
835050001001 <b>995 €</b>				! FRA: _____ cm
840010000170 <b>706 €</b>				
840010000180 <b>290 €</b>				
82999901001? <b>471 €</b>				

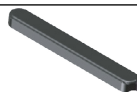

--	--	--

© Wolturnus A/S A-Run Winter 2024 v4.0



88100100003 <b>562 €</b>			AB = 29 cm AL = 23,5 cm	
88100110003 <b>562 €</b>			AB = 30,5 cm AL = 27,5 cm	
88100120003 <b>562 €</b>			AB = 27,5 cm AL = 23,5 cm	
88100130003 <b>562 €</b>			AB = 30 cm AL = 27 cm	
881001?00003 <b>818 €</b> <b>971 €</b>			AB = 41 cm AL = 37 cm	
881001?00003 <b>869 €</b> <b>1022 €</b>			AB = 31 cm AL = 26 cm	
881001?00003 <b>869 €</b> <b>1022 €</b>			AB = 34,5 cm AL = 31 cm	
681000010004 <b>180 €</b>				
681000010007 <b>97 €</b>				
	!			AS: _____ cm

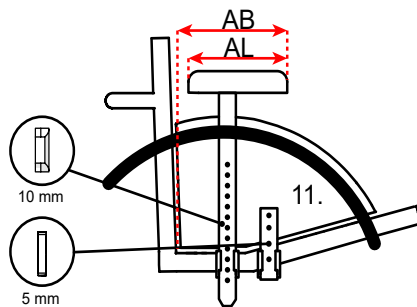



Fill in and send to Wolturnus - Ausfüllen und an Wolturnus senden - Udfyld og send til Wolturnus

Subject to Technical Modifications and Printing Errors / Technische Änderungen und Druckfehler vorbehalten  
Forbehold for tekniske ændringer og trykfejl

© Wolturnus A/S A-Run Winter 2024 v4.0



			1+	2+	3+	4+	5+
761000000010							
		<b>250 €</b>					

710000000001				
710099990010				
710099990012				
710099990013				
710099990011				

710099990001				
710099990003				
710099990004				
710099990002				
710099990000				

750000009000				!	
				_____ cm / _____ cm	
-					
750000000005		!		5cm Std.	7cm
				Medium Std.	Hard

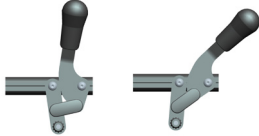
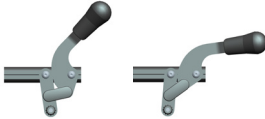
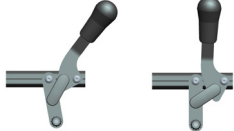
950599993?50			
950599990?50			

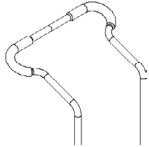
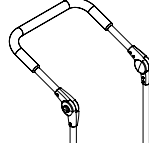

885110101001 <b>0 €</b>			
885110101003 <b>0 €</b>			
885110111001 <b>203 €</b>			
885110122002 <b>60 €</b> 88511012200? <b>120 €</b>			

8400002072XX <b>460 €</b>			
------------------------------	--	--	--

88520003100? <b>0 €</b>			
88520003100? <b>0 €</b>			
88520003100? <b>0 €</b>			
88520003100? <b>0 €</b>			
	<b>!</b>		_____ cm

884140000500 <b>230 €</b>			
884142531009 <b>450 €</b>			
884142301009 <b>520 €</b>			

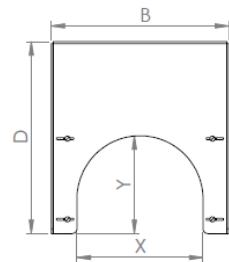
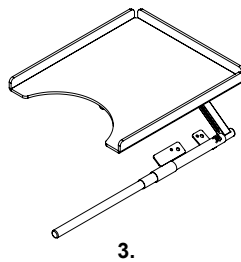
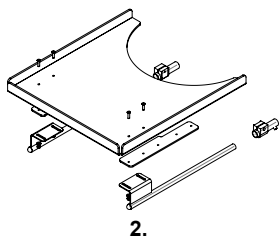
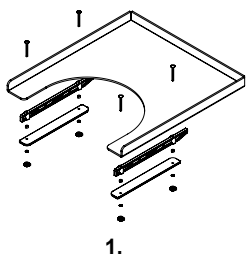
8401????0090 <b>395 €</b>			
870019000004 <b>990 €</b>			



--	--	--	--



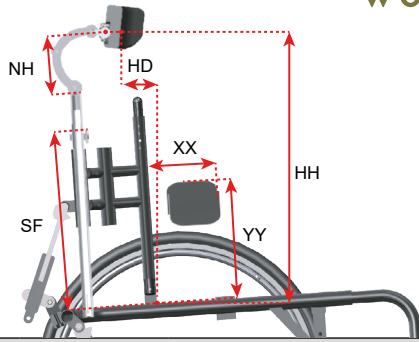



Fill in and send to Wolturnus - Ausfüllen und an Wolturnus senden - Udfyld og send til Wolturnus

Subject to Technical Modifications and Printing Errors / Technische Änderungen und Druckfehler vorbehalten  
Forbehold for tekniske ændringer og trykfejl

© Wolturnus A/S A-Run Winter 2024 v4.0

884100017001? <b>245 €</b> <b>353 €</b>					
951000080130 <b>92 €</b>				<b>NH:</b> _____ cm	
951000080131 <b>112 €</b>					
951000080141 <b>112 €</b>				<b>HH:</b> _____ cm	
951000080142 <b>112 €</b>					
84000010082? <b>409 €</b> <b>409 €</b>				<b>HD:</b> _____ cm	
84000010083? <b>184 €</b> <b>215 €</b> <b>215 €</b>					
84000010083? <b>281 €</b> <b>281 €</b> <b>281 €</b>					
84000010083? <b>562 €</b> <b>562 €</b>					
884100250100 <b>194 €</b>				<b>SF:</b> _____ cm	

884010101001 <b>215 €</b> <b>215 €</b>					
884010101010 <b>133 €</b>				<b>XX:</b> _____ cm	
884010101011 <b>133 €</b>					
884010101012 <b>133 €</b>				<b>YY:</b> _____ cm	
812200200060 <b>100 €</b>					

887000200011 <b>2.453 €</b>					
--------------------------------	--	--	--	--	--

771100000747 <b>112 €</b>					
------------------------------	--	--	--	--	--

--	--	--	--	--	--

	4"	5"	6"	
860010101401 0 €	-	-		
860010101253 0 €	-		-	
8600101020?? 0 €				
860010201??? 332 €				

























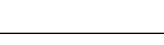





	12"	22"	24"	
8537281110?? 0 €				
8510??003609 0 €	-			





	12"	22"	24"	
9662????00?? 0 €	-			
9662??01000? 70 €	-			
9662??010009 150 €	-			
966224010022 150 €	-	-		
966224010007 70 €	-	-		

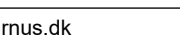

	12"	22"	24"	
8551??102009 0 €	-			
8555??000009 514 €	-			
8554????0009 322 €	-			

	12"	22"	24"	
8571??1021?? 332 €	-			

--	--

77110000067 <b>150 €</b>			
77110000071 <b>150 €</b>			
77110000055 <b>150 €</b>			
77110000079 <b>177 €</b>			
77110000155 <b>129 €</b>			
77110000159 <b>129 €</b>			
77110000111 <b>118 €</b>			
771 00000103 <b>118 €</b>			
77110000143 <b>144 €</b>			
77110000135 <b>144 €</b>			
77110000147 <b>177 €</b>			
77110000163 <b>177 €</b>			
77110000179 <b>129 €</b>			
77110000171 <b>129 €</b>			
77110000016 <b>177 €</b>			
77110000015 <b>177 €</b>			
77110000021 <b>150 €</b>			
77110000020 <b>150 €</b>			
77110000019 <b>150 €</b>			
77110000187 <b>187 €</b>			
77110000191 <b>187 €</b>			
77110000183 <b>187 €</b>			
77110000275 <b>177 €</b>			
77110000279 <b>177 €</b>			
77110000195 <b>215 €</b>			
77110000267 <b>215 €</b>			
77110000283 <b>208 €</b>			
77110000235 <b>150 €</b>			
77110000231 <b>150 €</b>			
77110000223 <b>150 €</b>			
77110000259 <b>193 €</b>			

	XXS	XS	S	M	L	LX	
7711000005?? <b>160 €</b>	-						
7711000005?? <b>172 €</b>	-						
7711000006?? <b>203 €</b>							
7711000006?? <b>215 €</b>							
7711000007?? <b>246 €</b>	-						

77110000076? <b>187 €</b>	-						
7711000007?? <b>115 €</b>	-	-				-	
77110000075? <b>129 €</b>	-	-				-	

--	--

--	--

000000001104 115 €		EN ISO 14971
P.4		
P.5		
P.6		
P.7		
P.8		
P.9		
P.10		
P.12		





