

Tailor-made Wheelchair



171000005000		
5700 €		
17100000500?		
5800 €		

Fill in and send to Wolturnus - Udfyld og send til Wolturnus

Subject to Technical Modifications and Printing Errors / Technische Änderungen und Druckfehler vorbehalten
Forbehold for tekniske ændringer og trykfejl

619000001009		
619000001109		
619000001209		
619000001309		
619000001409		
619000001509		
619000002009		
619000002109		
619000002509		
619000002809		
619000003209		
619000003309		
619000003409		
619000003509		
619000003709		
619000003809		
619000003909		
619000003009 750 €		
000000001102 0 €		

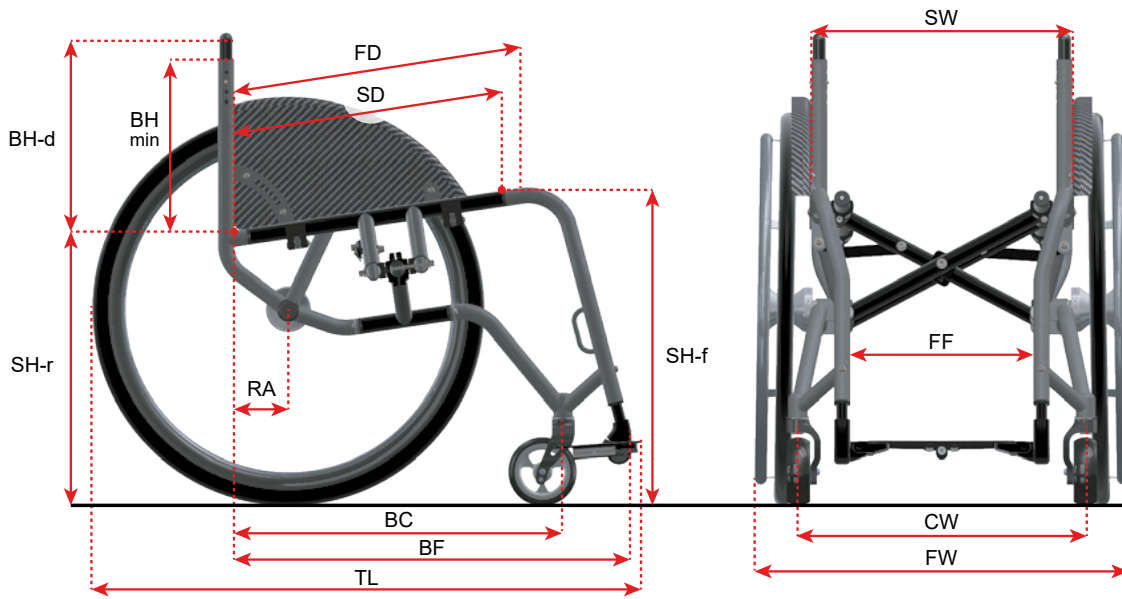

171000010??	!			SW: _____ cm
				FD: _____ cm
				SD: _____ cm
				SH-r _____ cm
				SH-f: _____ cm
				C: _____ °
				BH: _____ cm
				BH-d: _____ cm
	!			BH-max: _____ cm
				BH-min: _____ cm
	!			RA: _____ cm
				BF: _____ cm
				BC: _____ cm
				CW: _____ cm
				TW: _____ cm

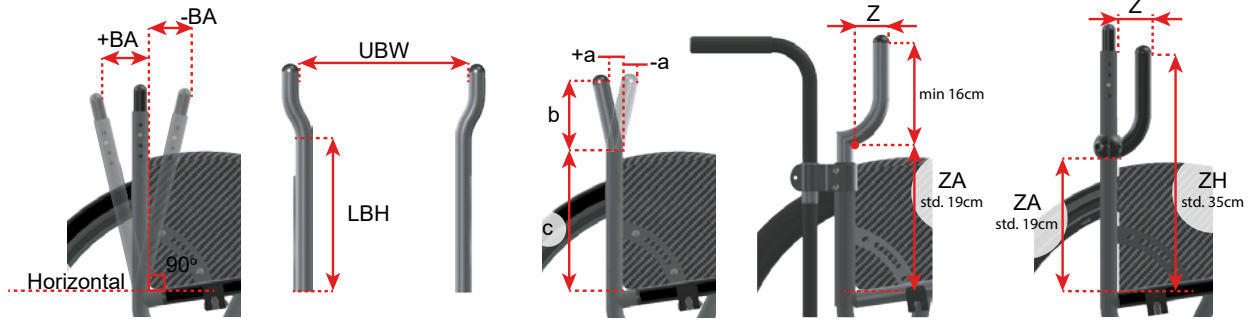

				BA: _____ ±cm	
812200200002 246 €				UBW: _____ cm	
812200200001 246 €				LBH: _____ cm	
812200200020 147 €				a: _____ cm	
				b: _____ cm	
				c: _____ cm	
8122002001?? 560 €	!			_____ cm	
8122002001?? 723 €					
82501000???? 560 €					
8122002001?? 930 €					ZA: _____ cm
8122002001?? 930 €					Z: _____ cm
				ZH: _____ cm	
8861101013?? 325 €					
8861101013?? 325 €					
				AF: _____ cm	
				AW: _____ cm	



--	--

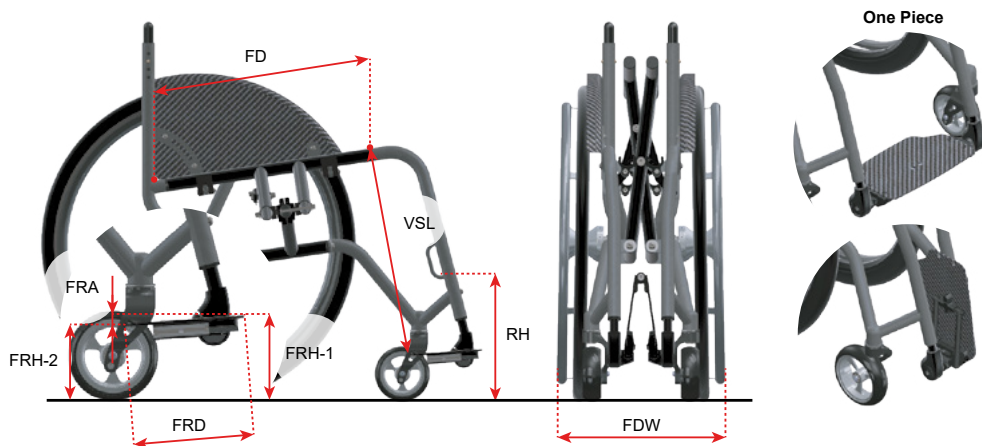



			VSL/USL: _____ cm
			FRH-1: _____ cm
			FRH-2: _____ cm
			-1,5 -3 +1,5 +3
			FRA: _____ cm
8350??010001 0 €			
8350??020001 0 €			
8350??030001 0 €			
8350??030001 0 €			
8350??050001 461 €		FF 22cm FF 24cm FF 26cm FF 28cm FF 30cm FF 32cm FF 34cm	
8350??060001 711 €		FF 22cm FF 24cm FF 26cm FF 28cm FF 30cm FF 32cm FF 34cm FF 36cm FF 38cm FF 40cm	
835099210001 68 €			
691000010001 68 €			RH: _____ cm

Fill in and send to Wolturnus - Ausfüllen und an Wolturnus senden - Udfyld og send til Wolturnus

Subject to Technical Modifications and Printing Errors / Technische Änderungen und Druckfehler vorbehalten
Forbehold for tekniske ændringer og trykfejl

© Wolturnus A/S Merlin Winter 2024 V4.0

				1+	2+	3+	4+	5+
761000000010 245 €								
710000000001 0 €								
710099990010 440 €								
710099990012 470 €								
710099990013 470 €								
710099990011 470 €								
710099990001 0 €								
710099990003 185 €								
710099990004 185 €								
710099990002 185 €								
710099990000 0 €								
750000009000 265 €			!	_____ cm / _____ cm				
- 0 €		!			5cm Std.	7cm		
750000000005 68 €					Medium Std.	Hard		

				
881000100003 0 €				
881000600003 0 €				
881000?0000 340 €				
88100010000? 0 €				
88100040000? 300 €				
8810005000?? 744 €				
88100020000? 725 €				
8810003000?? 800 €				

883124101014 240 €			
681000010002 70 €			
681000010052 70 €			
7670000000?? 170 €			



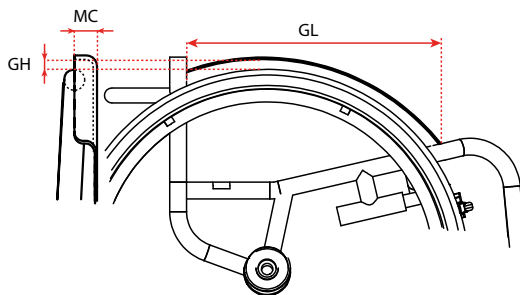

	GH:	_____ cm
	GL:	_____ cm
	MC:	_____ cm

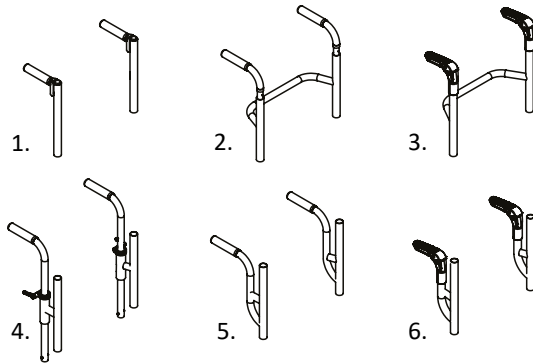





--	--



81310005?106 330 €		1.		
81310005?206 367 €				
81310005?108 330 €		2.		
81310005?208 367 €				
81310005?107 183 €	3.			
81310005?207 230 €				
81310005??02 524 €		4.		
81310005??04 367 €		5.		
81310005??05 576 €		6.		
				PH: _____ cm

69100002002? 275 €			
886210101001 340 €			
7600000100?? 68 €			
76100000000? 162 € 225 €			
7711000007?? 110 € 110 € 110 €			
771100000747 110 €			
953001040120 110 €			

--	--

885110101101 199 €			
885110111101 199 €			
885110201209 225 €			
885110201300 250 €			

951500020019 70 €			
-----------------------------	--	--	--

966401253410 966401003410		178 € 178 €	
------------------------------	--	------------------------------	-------------------------------------------------------------------------------------

966401253400 966401003400 966401003403 966401003402 966401003401 966401003404		0 € 0 € 0 € 0 € 0 € 0 €	
----------------------------------------------------------------------------------------------	--	----------------------------------------------------------------------------------	--------------------------------------------------------------------------------------



966401250120 966401250220 966401250320 966401250020		325 € 325 € 325 € 325 €	
966401000120 966401000220 966401000320 966401000020		325 € 325 € 325 € 325 €	
966401250?20 966401250620 966401250520 966401250420		377 € 377 € 377 € 377 €	
966401000?20 966401000620 966401000520 966401000420		377 € 377 € 377 € 377 €	

9521000000?		0 €	
		0 €	

--	--	--	--

	22"	24"	25"	26"	
85102??01009					0 €
85102?10100?	-			-	0 €
8510??101002				-	257 €
851124201009	-		-	-	471 €

	22"	24"	25"	26"		
85352?101008					895 €	
85352?101208					895 €	
85352?101508	-				895 €	
85352?101308					895 €	
85352?102108					895 €	
85352?101009					695 €	
85352?101209					695 €	
85352?101509	-				695 €	
85352?101309					695 €	
85352?101?09					695 €	

85352?101608					950 €	
85352?101408	-			-	950 €	
85352?101808					950 €	
85352?101708					950 €	
85362?241008					950 €	
85362?241208	-				950 €	
85362?241508					950 €	
85362?241308					950 €	
85362?181008					950 €	
85362?181208	-				950 €	
85362?181508					950 €	
85362?181308					950 €	

--	--

	22"	24"	25"	26"	
96622?010001				-	0 €
96622?01000?					68 €
96622?010009					146 €
96622?010021	-				146 €
966224010013	-		-	-	68 €
96622?011008	-		-	-	68 €
966224010007	-				68 €

85512?10200?					0 €
85512?102008	-			-	194 €
85502?103009	-				178 €
85552?000009					503 € 629 €
8554202?0601					315 €
8554262?0601	-				575 €
8554272?0601	-				575 €
8554282?0601					700 €
9669282?0602					700 €
8554302?0601					700 €
8554502?060?	-			-	700 €
8554502?060?	-			-	700 €

			!		
--	--	--	---	--	--

85712?102009					178 €
--------------	--	--	--	--	-------

--	--	--	--	--	--

000000001104 100 €					
-----------------------	--	--	--	--	--

EN ISO 14971

--	--	--	--	--	--

P.4	
P.5	
P.6	
P.8	
P.9	
P.10	
P.11	
P.12	

